

# PAKISTAN DEFENCE OFFICERS HOUSING AUTHORITY, KARACHI

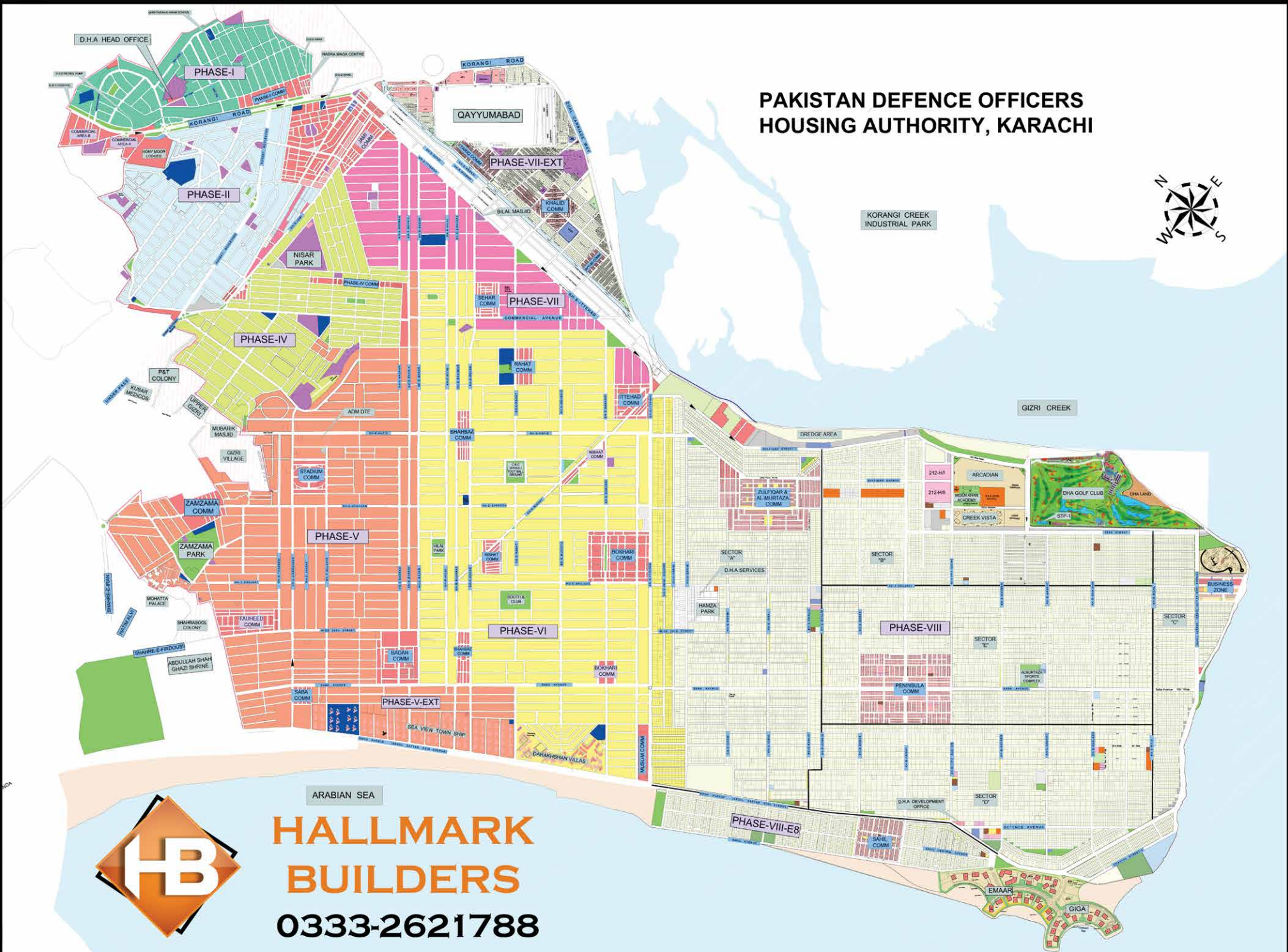

**HALLMARK BUILDERS**  
**0333-2621788**

# INDUSTRIAL COMM. PHASE-I

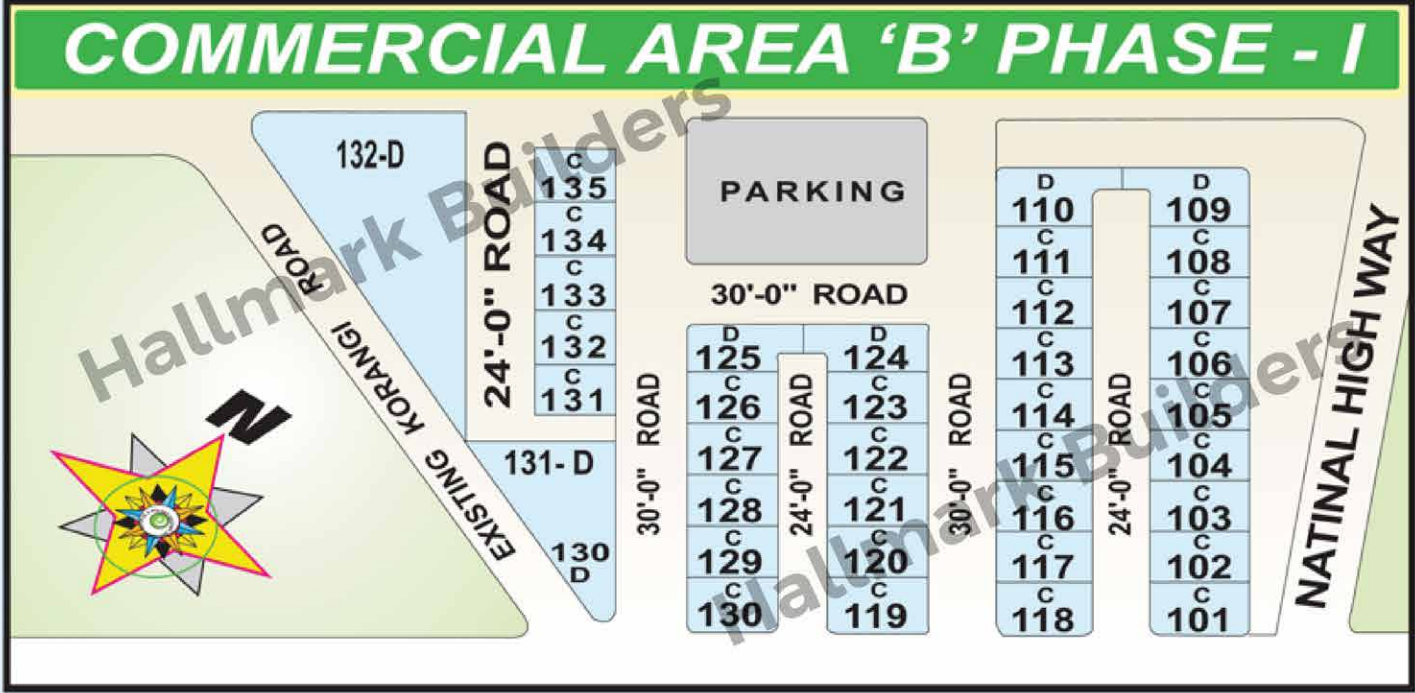
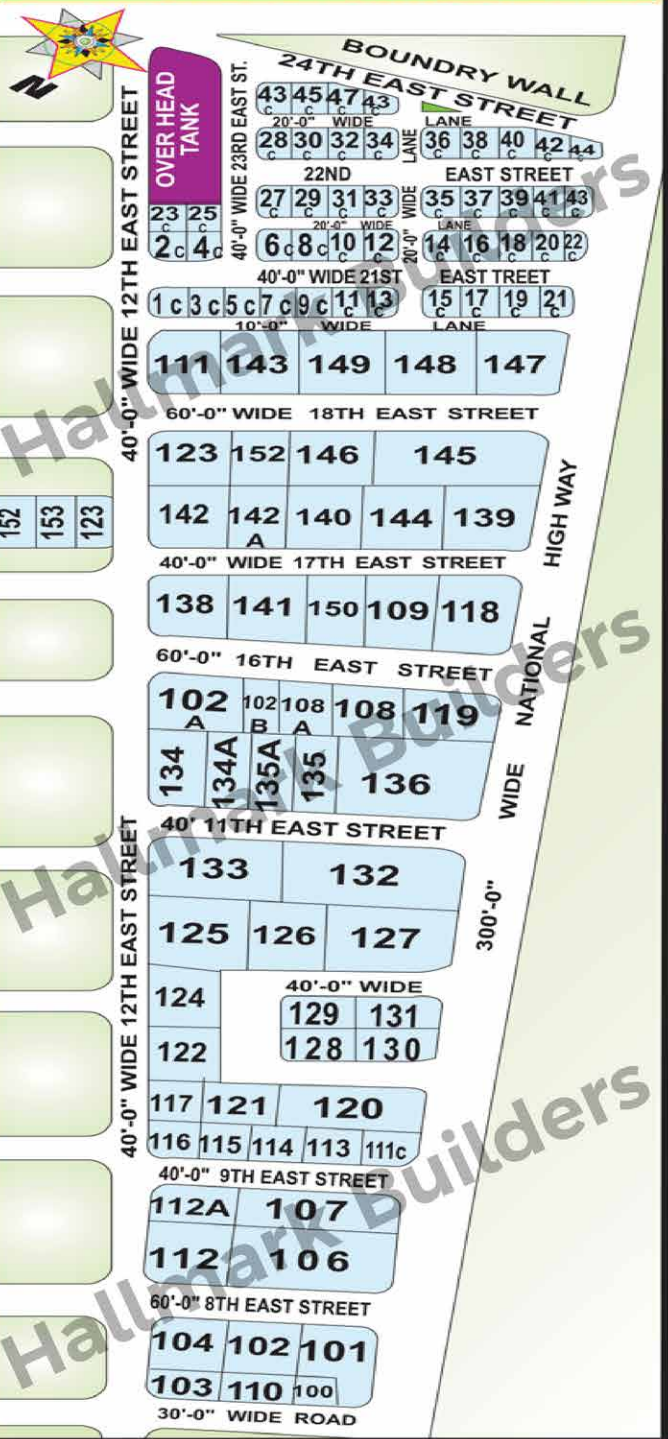

# COMMERCIAL AREA 'A' PHASE II

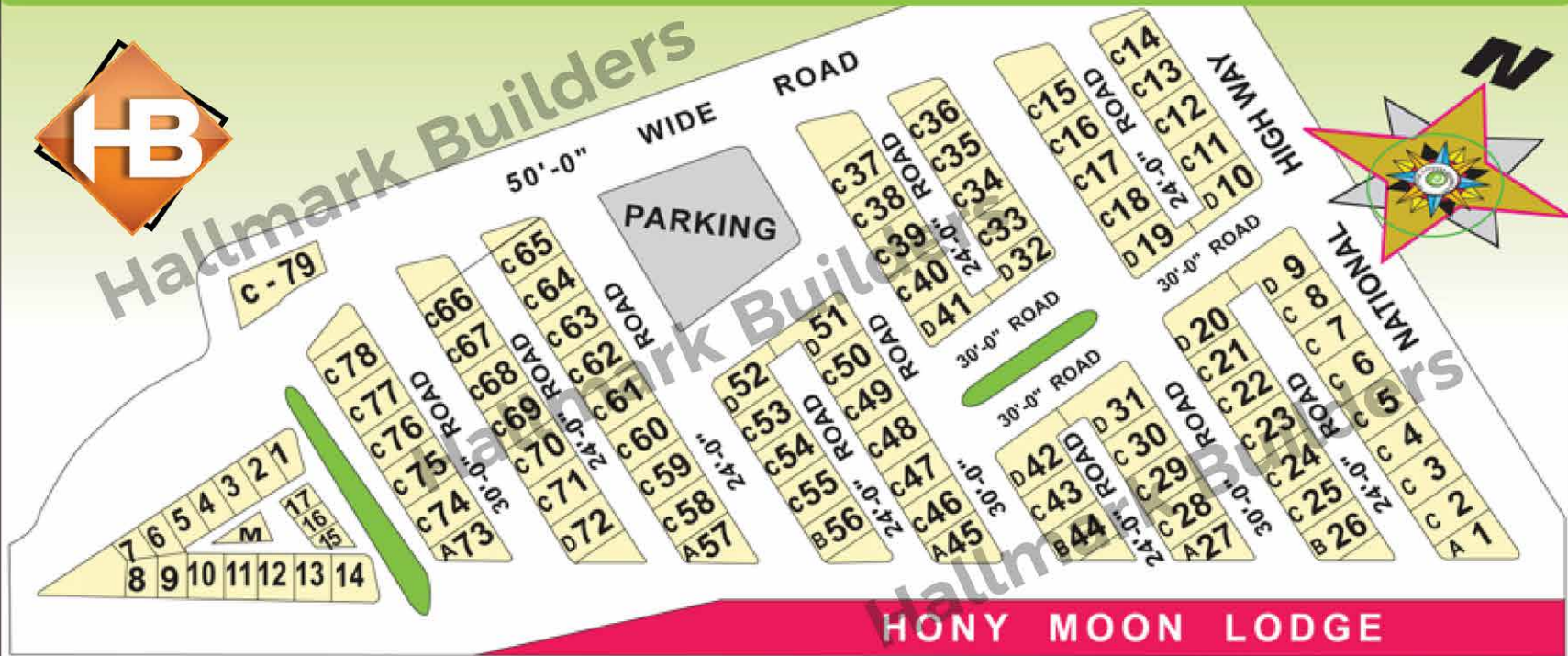

HONY MOON LODGE

# SUNSET BOLEVARD COMM. AREA PHASE II

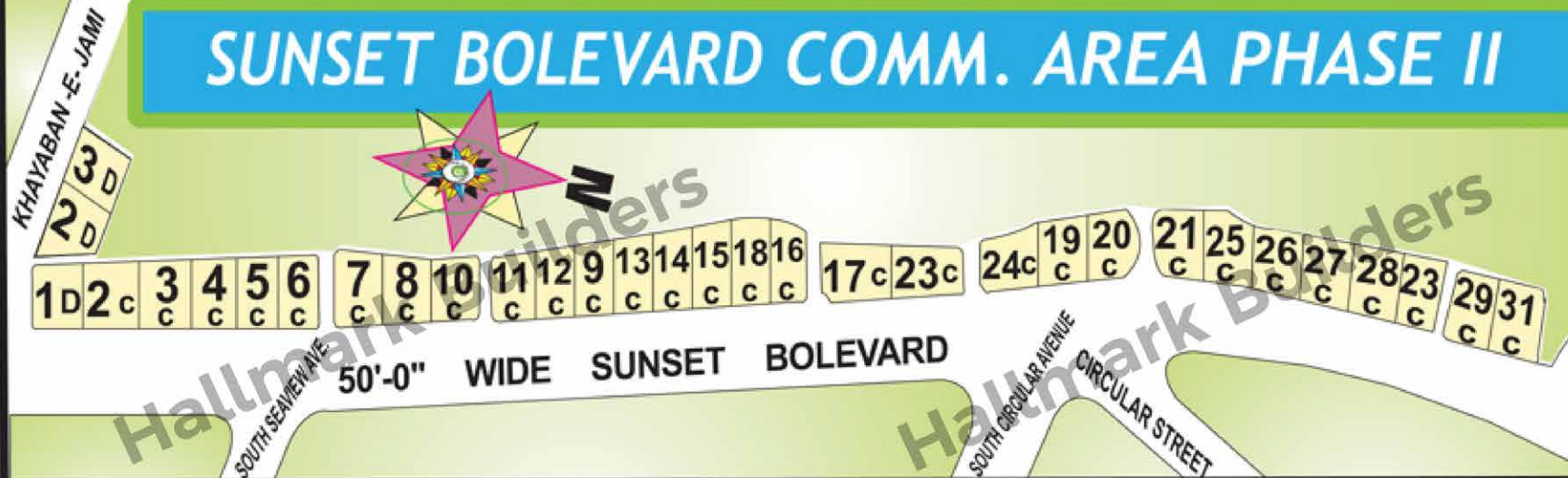

# COMMERCIAL AREA PHASE - II Ext.



Hallmark Builders  
KHAYABAN -E- ITEHAD  
IIMMOMIWAJ



# SUNSET COMMERCIAL AREA PHASE - IV

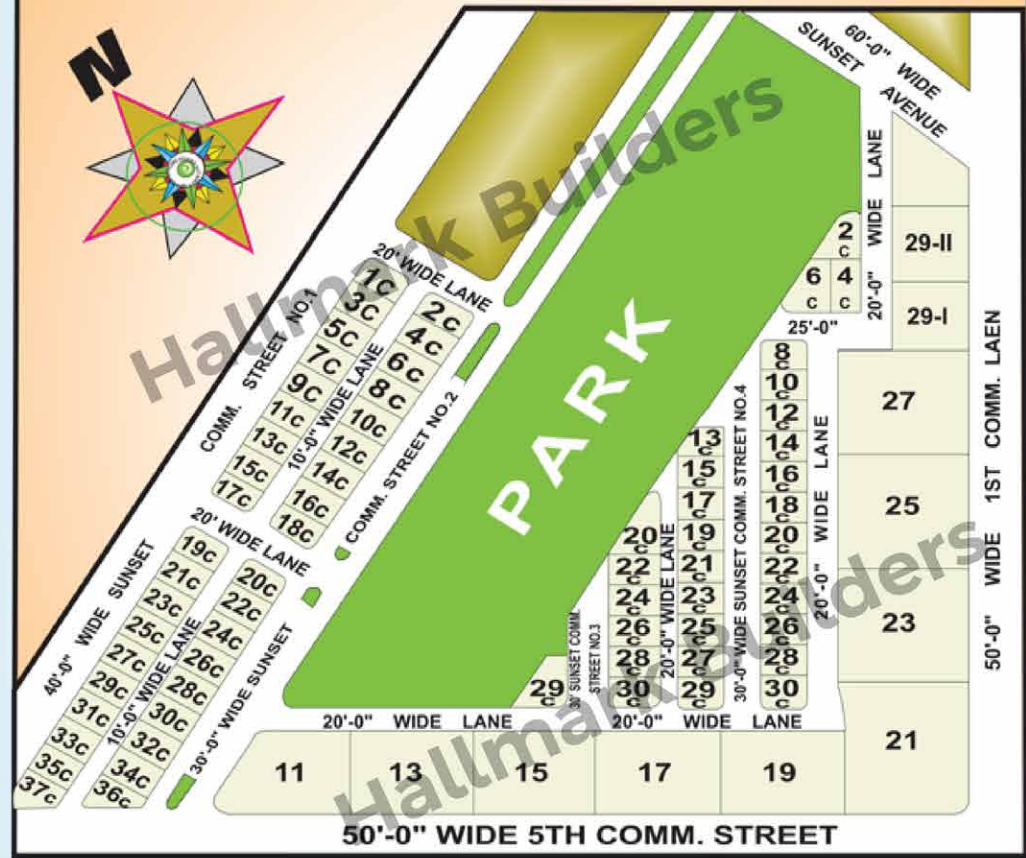

# 9TH & 10TH COMMERCIAL STREET PHASE-IV

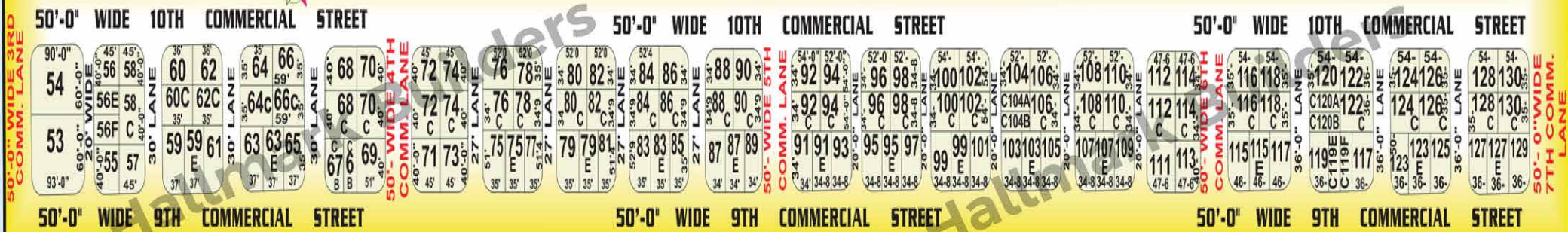

# TAUHEED COMMERCIAL AREA PHASE -V

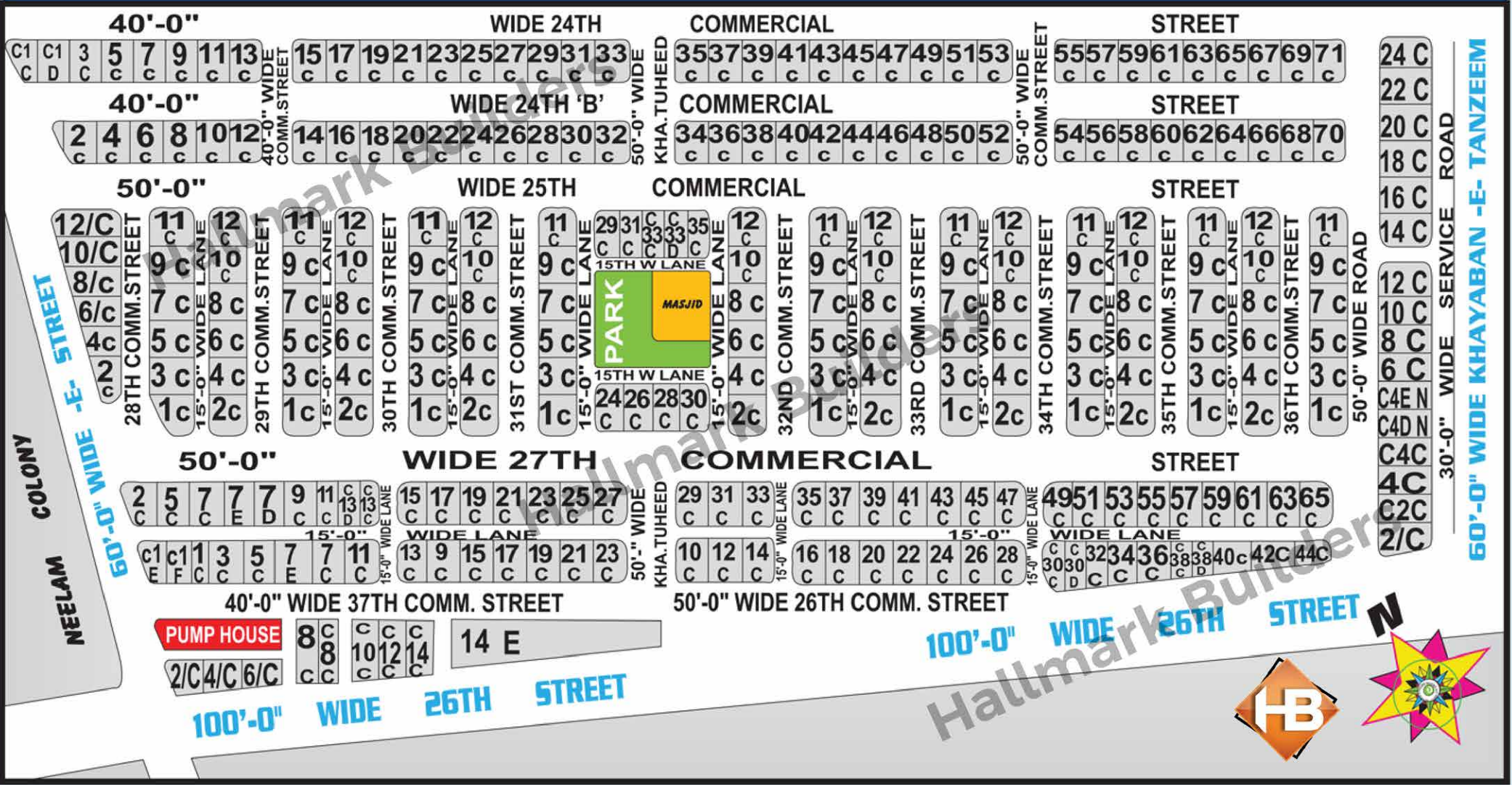

60'-0" WIDE KHAYABAN -E- TANZEEM

30'-0" WIDE SERVICE ROAD

24 C  
22 C  
20 C  
18 C  
16 C  
14 C  
12 C  
10 C  
8 C  
6 C  
4C  
C2C  
2/C

STREET

STREET

STREET

STREET

100'-0" WIDE 26TH STREET N



PUMP HOUSE

100'-0" WIDE 26TH STREET

40'-0" WIDE 37TH COMM. STREET

50'-0" WIDE 26TH COMM. STREET

NEELAM COLONY  
60'-0" WIDE -E- STREET



40'-0" WIDE 24TH COMMERCIAL STREET  
 40'-0" WIDE 24TH 'B' COMMERCIAL STREET  
 50'-0" WIDE 25TH COMMERCIAL STREET  
 50'-0" WIDE 27TH COMMERCIAL STREET  
 50'-0" WIDE 26TH COMM. STREET  
 40'-0" WIDE 37TH COMM. STREET

# BADAR COMMERCIAL AREA PHASE - V (200 SQ.YDS.)



40' 31ST STREET

40' 30TH STREET

40' 29TH STREET

40' 28TH STREET

40' 27TH STREET



60' WIDE SABA AVENUE

60' WIDE SABA AVENUE

26 STREET

60'-0" WIDE

40'-0" WIDE  
 51494745434139373533  
 15'-0" WIDE LANE  
 39E37E35E33E31E29E27E25E

COMM. STREET No.7-A  
 3129272523211917191311 9 7  
 15'-0" WIDE LANE  
 23E21E19E17E15E13E11E9-E 7-E 5-E

5 3 1  
 C C C  
 3 3 1  
 D E E

54  
 I  
 55  
 54 II/I 54 II/II

15'-0" WIDE LANE  
 2-c 585656545250484644  
 4-c 5755535149474543  
 6-c  
 8-c  
 10-c  
 40'-0" BADAR COMM. ST. No.8  
 7-c 54-c 52-c 50-c 48-E 48-c 46-c 3-c  
 9-c 55-c 53-c 51-c 49-E 49-c 47-c 5-c  
 11-c 55-c 53-c 51-c 49-E 49-c 47-c 5-c  
 12-c  
 14-c  
 16-c  
 18-c  
 20-c  
 40'-0" BADAR COMM. ST. No.9  
 5856545250484644  
 20'-0" WIDE LANE  
 5755535149474543  
 15'-0" WIDE LANE

23'-0" BADAR COMM. ST. No.7  
 42403836343230282624222018  
 40'-0" BADAR COMM. ST. No.8  
 2-c 1-c 31292725  
 4-c 3-c 30'-0" BADAR COMM. ST. No.8A  
 6-c 5-c 4-c 5-E 3-E 3-c  
 8-c 7-c 6-c 10-LANE 1-E 5-c  
 10-c 9-c 8-c 15-LANE 2-E 7-c  
 12-c 11-c 30'-0" COMM. STREET No.9A  
 14-c 13-c 32302826  
 40'-0" BADAR COMM. ST. No.9  
 41393735333129272523211917  
 15'-0" WIDE LANE

161412C10C108 6 4 2  
 20'-0" WIDE LANE  
 15 13 11 9 7 5 3 1  
 40'-0" BADAR COMM. ST. No.8  
 4-c 10-c 8-c 6-c 4-c 3-c  
 6-c 8-c 6-c 4-c 4-c 8-c  
 8-c 11-c 9-c 7-c 5-c 3-c 10-E  
 40'-0" BADAR COMM. ST. No.9  
 16141210 8 6 4 2  
 15 13 11 9 7 5 3 1  
 15'-0" WIDE LANE

60'-0" WIDE  
 15'-0" WIDE LANE  
 22-c 5856545250484644  
 24-c  
 26-c 5755535149474543  
 28-c  
 30-c  
 40'-0" BADAR COMM. ST. No.11  
 29-c 54-c 52-c 50-c 48-E 48-c 46-c C-17-C  
 31-c 55-c 53-c 51-c 49-E 49-c 47-c C-17-D  
 33-c 55-c 53-c 51-c 49-E 49-c 47-c C-19-C  
 31-E 55-c 53-c 51-c 49-E 49-c 47-c C-19-D  
 33-E 55-c 53-c 51-c 49-E 49-c 47-c C-19-E  
 21-c  
 40'-0" BADAR COMM. ST. No.12  
 5856545250484644  
 20'-0" WIDE LANE  
 5755535149474543  
 15'-0" WIDE LANE

BADAR COMM.  
 15'-0" WIDE LANE  
 42403836343230282624222018  
 40'-0" BADAR COMM. ST. No.11  
 16-c 15-c 31292725  
 18-c 17-c BADAR COMM. ST. No.11A  
 20-c 19-c 18-c 23-E 21-E 17-c  
 22-c 21-c C-22 24-E 22-E 19-E 19-c  
 24-c 23-c C-22 24-E 22-E 19-E 21-c  
 26-c 25-c BADAR COMM. ST. No.12A  
 28-c 27-c 32302826  
 40'-0" BADAR COMM. ST. No.12  
 41393735333129272523211917  
 15'-0" WIDE LANE

ST. No.10  
 15'-0" WIDE LANE  
 16 14 12 10 8 6 4 2  
 20'-0" WIDE LANE  
 15 13 11 9 7 5 3 1  
 40'-0" BADAR COMM. ST. No.11  
 18-c 12-c 10-c 8-c 6-c 4-c 28-c  
 20-c 20-c 20-c 20-c 20-c 30-c  
 20-E 11-c 9-c 7-c 5-c 3-c 30-E  
 22-c 22-c 32-c  
 40'-0" BADAR COMM. ST. No.12  
 16141210 8 6 4 2  
 15 13 11 9 7 5 3 1  
 15'-0" WIDE LANE

60'-0" WIDE

KHAYABAN -E-

BADAR

# ZAMZAMA COMM. -V 200 SQ.YDS.







# SABA COMM. PHASE V Ext.

## 80'-0" WIDE KHAYABAN -E- SHAMSHIR

33RD STREET



30'-0" WIDE SABA

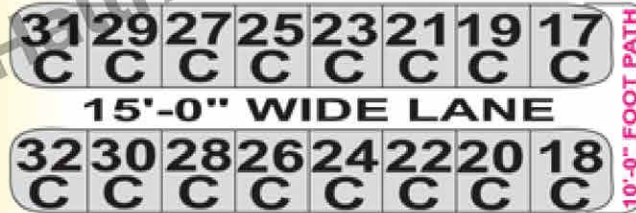

40'-0" WIDE SABA

40'-0" WIDE



30'-0" WIDE SABA



30'-0" WIDE SABA

COMM. STREET NO.5



COMM. STREET NO.1

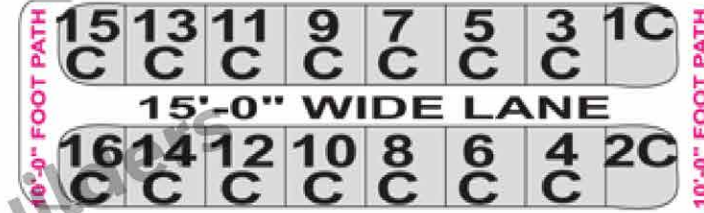

COMM. STREET NO.2

40'-0" WIDE SABA

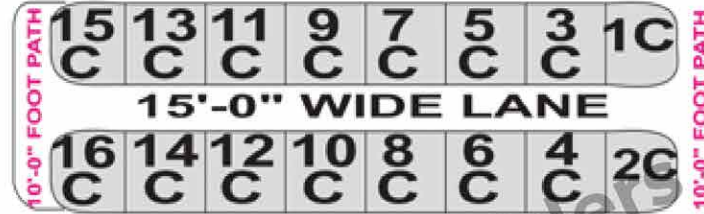

COMM. STREET NO.3



COMM. STREET NO. A

60'-0" WIDE SABA AVENUE





# ITTEHAD COMMERCIAL AREA PHASE - VI





# NISHAT COMMERCIAL AREA PHASE -VI

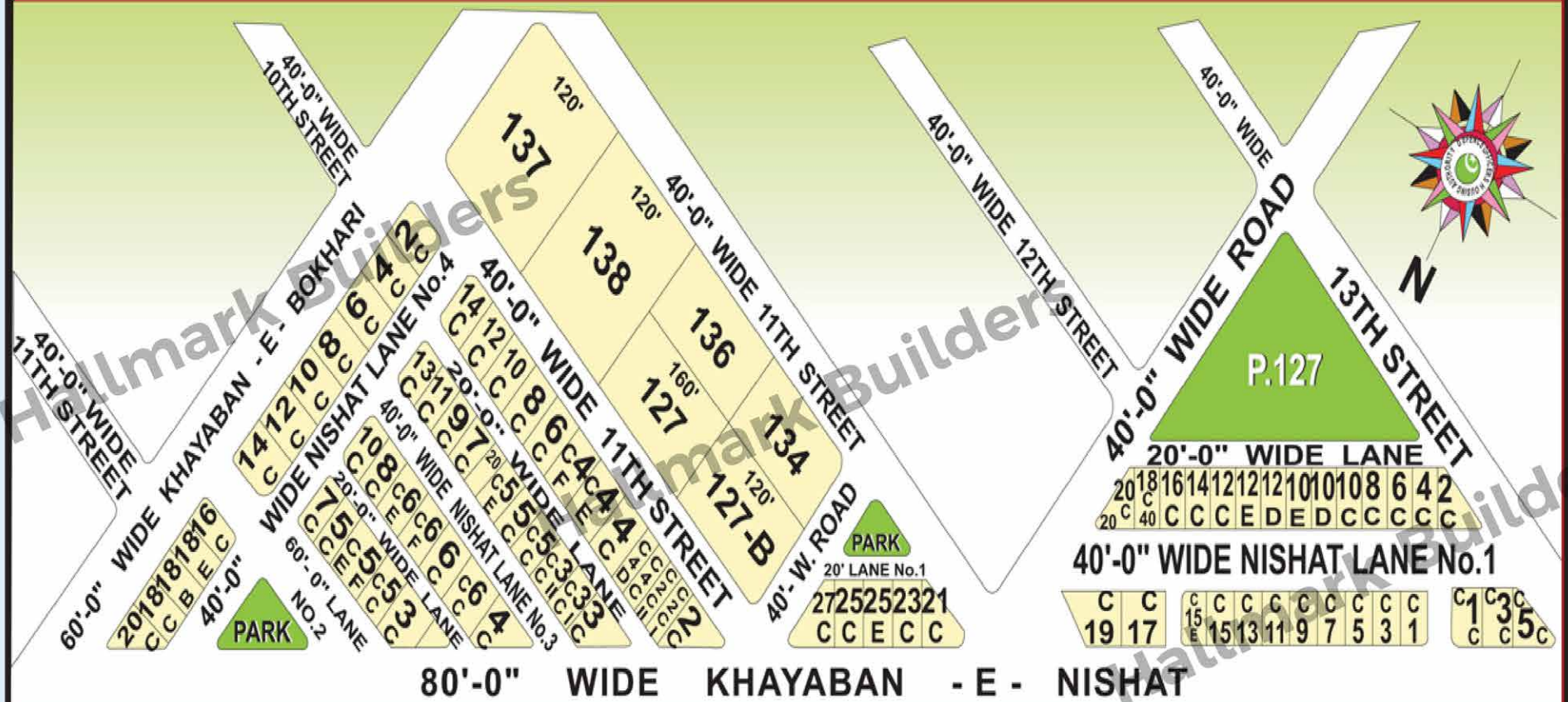

# RAHAT COMMERCIAL AREA PHASE VI



60'-0" WIDE POPULAR AVENUE

60'-0" WIDE

1	3	5	7	9	11	13
C	C	C	C	C	C	C

40'-0" WIDE

2	4	6	8	10	12	14
C	C	C	C	C	C	C

15'-0"

1	3	5	7	9	11	13
C	C	C	C	C	C	C

40'-0" WIDE

2	4	6	8	10	12	14
C	C	C	C	C	C	C

15'-0"

1	3	5	7	9	11	13
C	C	C	C	C	C	C

40'-0" WIDE

2	4	6	8	10	12	14
C	C	C	C	C	C	C

60'-0" WIDE

ROAD  
WIDE ROAD  
WIDE ROAD  
WIDE ROAD

KHAYABAN -E-

15	17	19	21	23	25	27	29
C	C	C	C	C	C	C	C

RAHAT

16	18	20	22	24	26	28	30
C	C	C	C	C	C	C	C

WIDE

15	17	19	21	23	25	27	29
C	C	C	C	C	C	C	C

RAHAT

16	18	20	22	24	26	28	30
C	C	C	C	C	C	C	C

WIDE

15	17	19	21	23	25	27	29
C	C	C	C	C	C	C	C

RAHAT

16	18	20	22	24	26	28	30
C	C	C	C	C	C	C	C

KHAYABAN -E-

ROAD  
WIDE ROAD  
WIDE ROAD

RAHAT

31	33	35	37	39	41	43
C	C	C	C	C	C	C

LANE No.1

32	34	36	38	40	42	44
C	C	C	C	C	C	C

LANE

31	33	35	37	39	41	43
C	C	C	C	C	C	C

LANE No.2

32	34	36	38	40	42	44
C	C	C	C	C	C	C

LANE

31	33	35	37	39	41	43
C	C	C	C	C	C	C

LANE No.3

32	34	36	38	40	42	44
C	C	C	C	C	C	C

40'-0" WIDE 5TH STREET





# SHAHBAZ COMMERCIAL AREA PHASE -VI 100 SQ. YDS



**100' -0" WIDE**

45	43	41	39	37	35	33	31	29	27	25	23
C	C	C	C	C	C	C	C	C	C	C	C

20'-0" WIDE LANE

46	44	42	30	38	36	34	32	30	28	26	24
C	C	C	C	C	C	C	C	C	C	C	C

30'-0" WIDE SHAHBAZ

45	43	41	39	37	35	33	31	29	27	25	23
C	C	C	C	C	C	C	C	C	C	C	C

30'-0" WIDE SHAHBAZ

46	44	42	40	38	36	34	32	30	28	26	24
C	C	C	C	C	C	C	C	C	C	C	C

20'-0" WIDE LANE

45	43	41	39	37	35	33	31	29	27	25	23
E	E	E	E	E	E	E	E	E	E	E	E

60' -0" WIDE

**KHAYABAN -E- SHAHBAZ**

21	19	17	15	13	11	9	7	5	3	1
C	C	C	C	C	C	C	C	C	C	C

20'-0" WIDE LANE

22	20	18	16	14	12	10	8	6	4	2
C	C	C	C	C	C	C	C	C	C	C

COMM. STREET No.1

21	19	17	15	13	11	9	7	5	3	1
C	C	C	C	C	C	C	C	C	C	C

COMM. STREET No.2

22	20	18	16	14	12	10	8	6	4	2
C	C	C	C	C	C	C	C	C	C	C

20'-0" WIDE LANE

21	19	17	15	13	11	9	7	5	3	1
E	E	E	E	E	E	E	E	E	E	E

KHAYABAN -E- SEHAR

**120' WIDE KHAYABAN -E- HAFIZ**





# DARKSHAN SHOPPING CENTER - VI

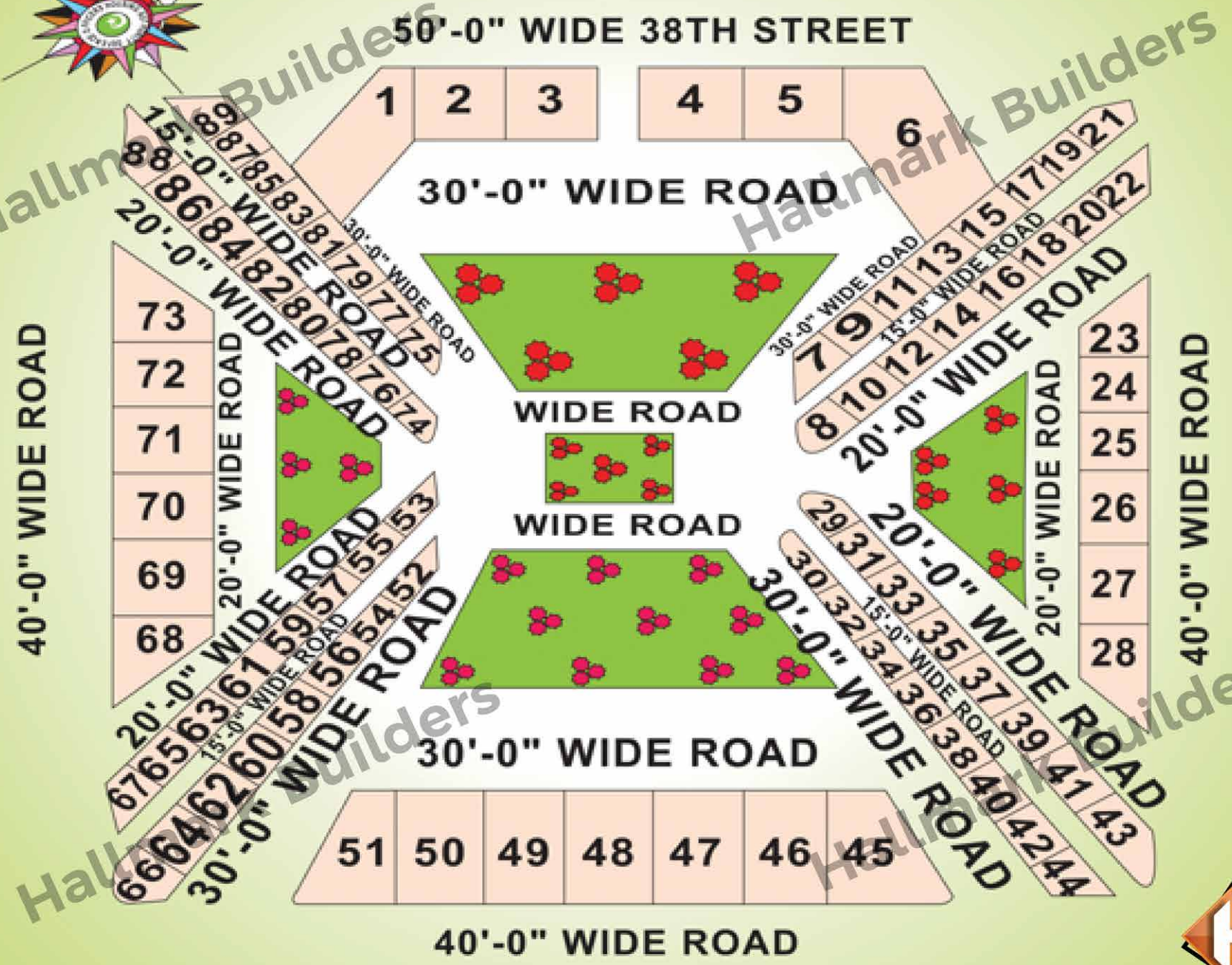



# BOKHARI COMM. PHASE VI

(100 SQ.YDS.)

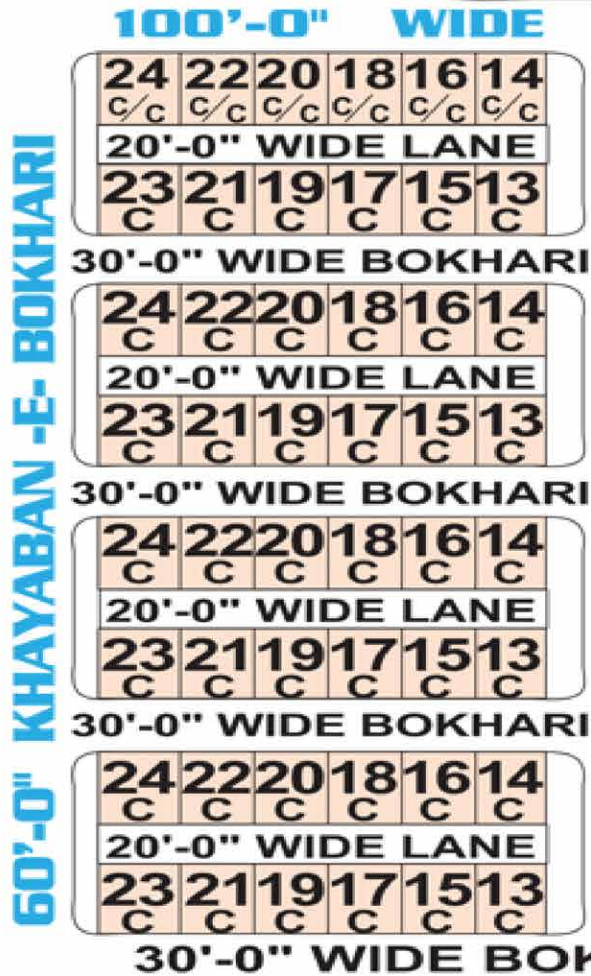

**60'-0" WIDE ROAD**

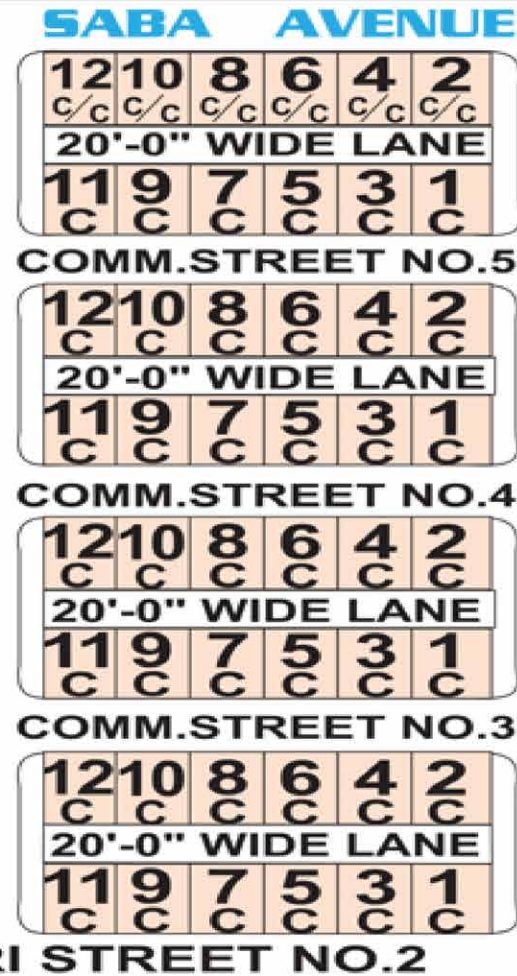

**60'-0" KHAYABAN -E- BOKHARI**

**60'-0" KHAYABAN -E- BOKHARI**



**40'-0" WIDE 29TH STREET**



# SEHAR COMM. AREA PHASE -VII (200 SQ. YDS.)

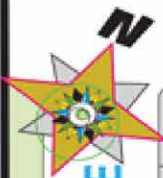

**AVENUE**

**COMMERCIAL**

**WIDE**

**80'-0"**

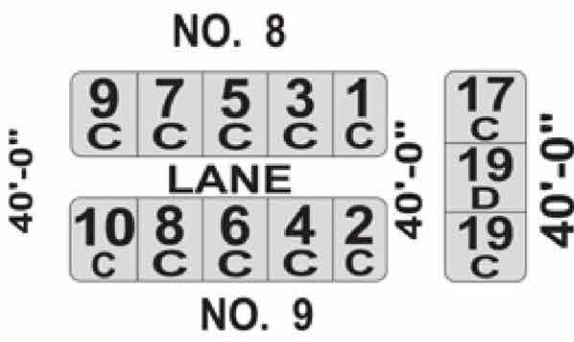
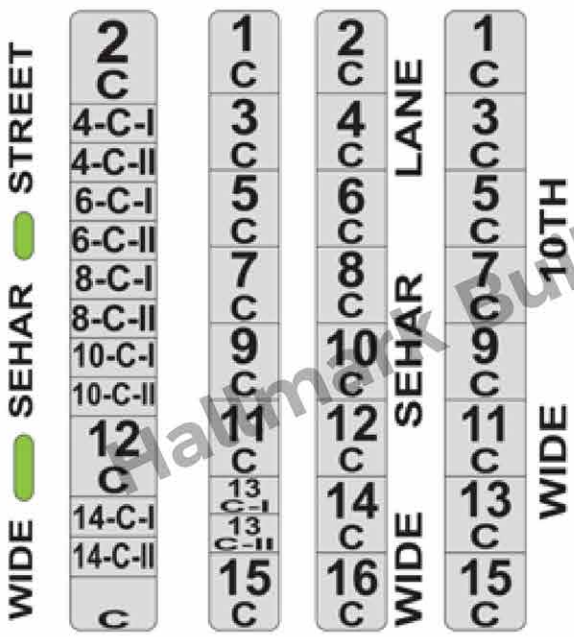
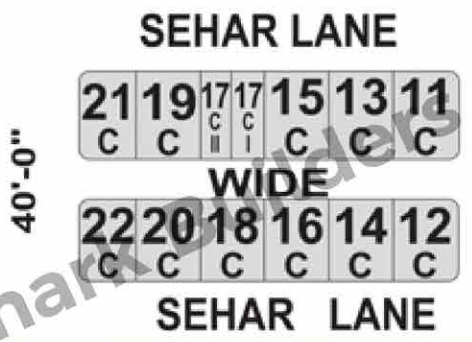
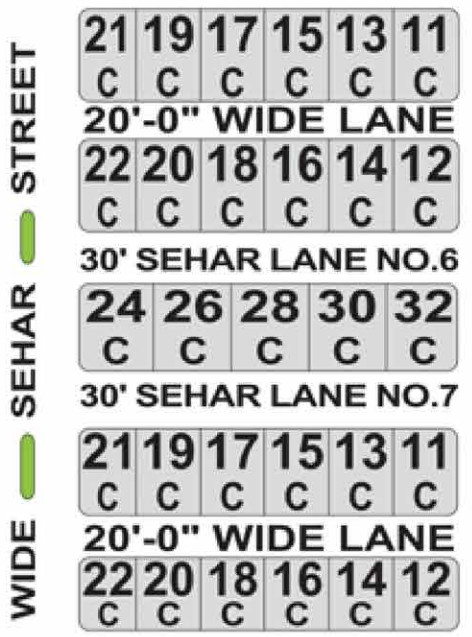
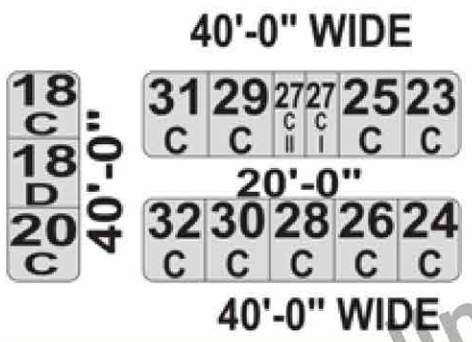
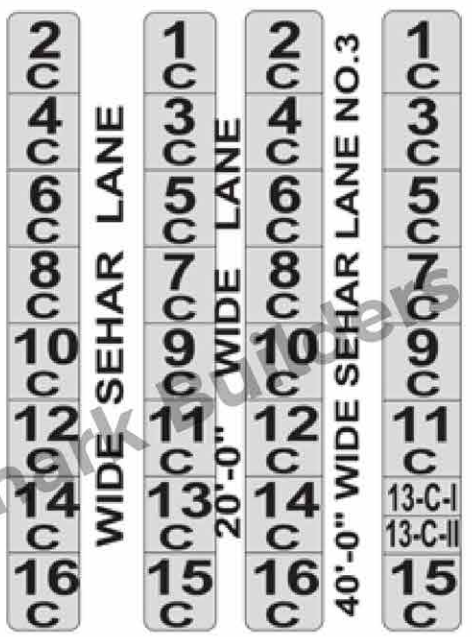
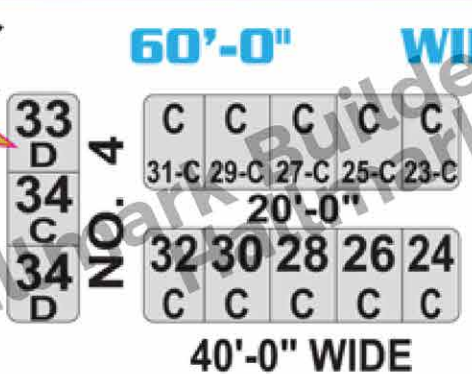

# AYOBIYA COMM. VII Ext.



## KH-AZIZ BHATTI SHAHEED SERVICE ROAD

2	4 <sup>C</sup>	4 <sup>C</sup>	6	6 <sup>B</sup>	8	PARKING	14 <sup>C</sup>	14 <sup>C</sup>	14 <sup>C</sup>	14 <sup>C</sup>	16	16
C	C	C	C	B	C		C	B	C	B	C	C

1	3	5	7	9	11	13	15	17 <sup>C</sup>	17 <sup>C</sup>	19	19	21	23
C	C	C	C	C	C	C	C	C	C	C	C	C	C

### AYOBIYA COMM ST . 1

2	4	4 <sup>C</sup>	6	6 <sup>B</sup>	8	PARKING	22	22	24 <sup>C</sup>	26 <sup>C</sup>	26	28
C	C	C	C	B	C		C	B	C	C	C	C

1	3	5	7	9	11	13	15	17	19	21	23	25	27
C	C	C	C	C	C	C	C	C	C	C	C	C	C

### AYOBIYA COMM ST . 2

2	4	4 <sup>C</sup>	6	6 <sup>B</sup>	8	PARKING	22	22	24 <sup>C</sup>	26 <sup>C</sup>	26	28
C	C	C	C	B	C	KESC	C	B	C	C	C	C

1	3	5	7	9	11	13	15	17	19	21	23	25	27
C	C	C	C	C	C	C	C	C	C	C	C	C	C

### AYOBIYA COMM ST . 3

2	4	4 <sup>C</sup>	6	6 <sup>B</sup>	8	PARKING	22	22	24 <sup>C</sup>	26 <sup>C</sup>	26	28
C	C	C	C	B	C		C	B	C	C	C	C

1	3	5	7	9	11	13	15	17	19	21	23	25	27
C	C	C	C	C	C	C	C	C	C	C	C	C	C

### AYOBIYA COMM ST . 4

2	4	4 <sup>C</sup>	6	6 <sup>B</sup>	8	PARKING	22	22	24 <sup>C</sup>	26 <sup>C</sup>	26	28
C	C	C	C	B	C		C	B	C	C	C	C

70	72	74	76	78	80	82	84	86	88	90	92	94	96
C	C	C	C	C	C	C	C	C	C	C	C	C	C

40' WIDE 1st Street

40'-0" WIDE KH - E - ANWARI SHAHEED

60'-0" WIDE KH - E - AZEEM





# KHALID COMMERCIAL PHASE - VII EXT.



60'-0" WIDE KH - E - MUHAMMED

HUSSAIN SHAHEED

SHABBIR SHAHEED

SARWAR SHAHEED

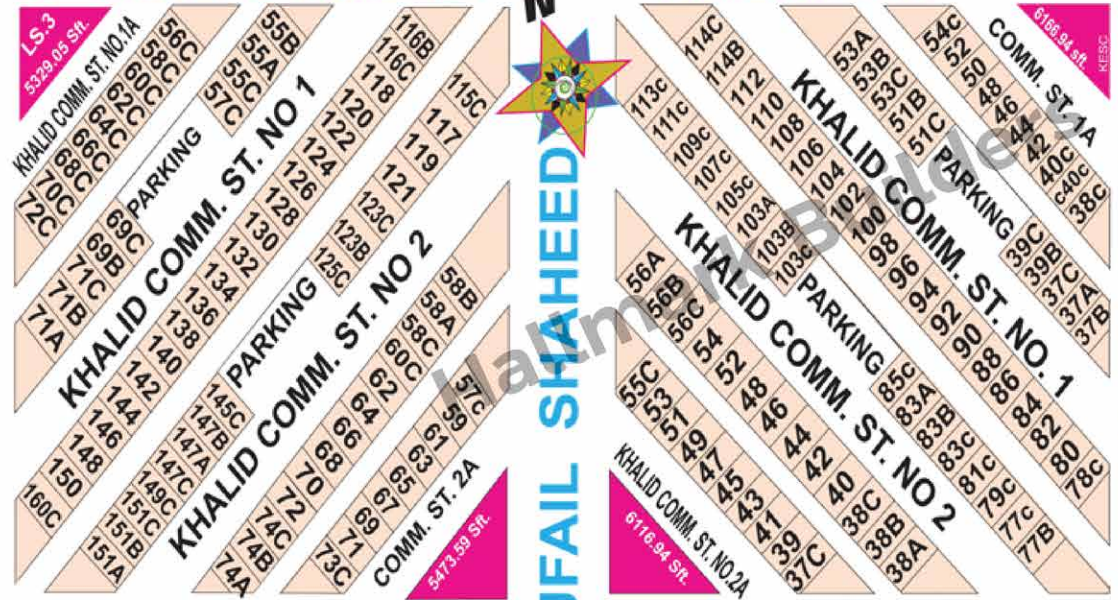

KH - E - AZIZ BHATTI

SHAHEED

38	40	42	44	46	48	50	52	54	56	58	60	62	64	66	68	70	72	74	76	78	80	82
S	S	S	S	S	S	S	S	S	S	S	S	S	S	S	S	S	S	S	S	S	S	S
37	39	41	43	45	47	49	51	53	55	57	59	61	63	65	67	69	71	73	75	77	79	81
S	S	S	S	S	S	S	S	S	S	S	S	S	S	S	S	S	S	S	S	S	S	S

40'-0" WIDE KHALID COMM. STREET NO.3

1	3	5	7	9	11	13	15	17	19	21	25	27	29	31	33	35	37	39	41	43	45	47
C	C	C	C	C	C	C	C	C	C	C	C	C	C	C	C	C	C	C	C	C	C	C

40'-0" WIDE KHALID COMM. STREET NO.4

2	4	6	8	10	12	14	16	18	PARKING		34	34	C	C	C	C	36	38	40	42	44	46	48
C	C	C	C	C	C	C	C	C	C	C	C	B	C	A	B	D	C	C	C	C	C	C	C

40'-0" WIDE KHALID COMM. STREET NO.5

2	4	6	8	10	12	14	16	18	20	PARKING		38	38	C	C	C	C	40	42	44	46	48	50	52
C	C	C	C	C	C	C	C	C	C	C	C	C	B	C	A	B	D	C	C	C	C	C	C	C

1	3	5	7	9	11	13	15	17	19	21	23	25	27	29	31	33	35	37	39	41	43	45	47	49	51
C	C	C	C	C	C	C	C	C	C	C	C	C	C	C	C	C	C	C	C	C	C	C	C	C	C

50'-0" WIDE KH - E -



KH - E - MUHAMMAD

100'-0" WIDE KH - E - TUFAIL SHAHEED



AKRAM SHAHEED

50'-0" WIDE KH - E -

(CLEAR VIEW)

# JAMI COMM. AREA PH. VII

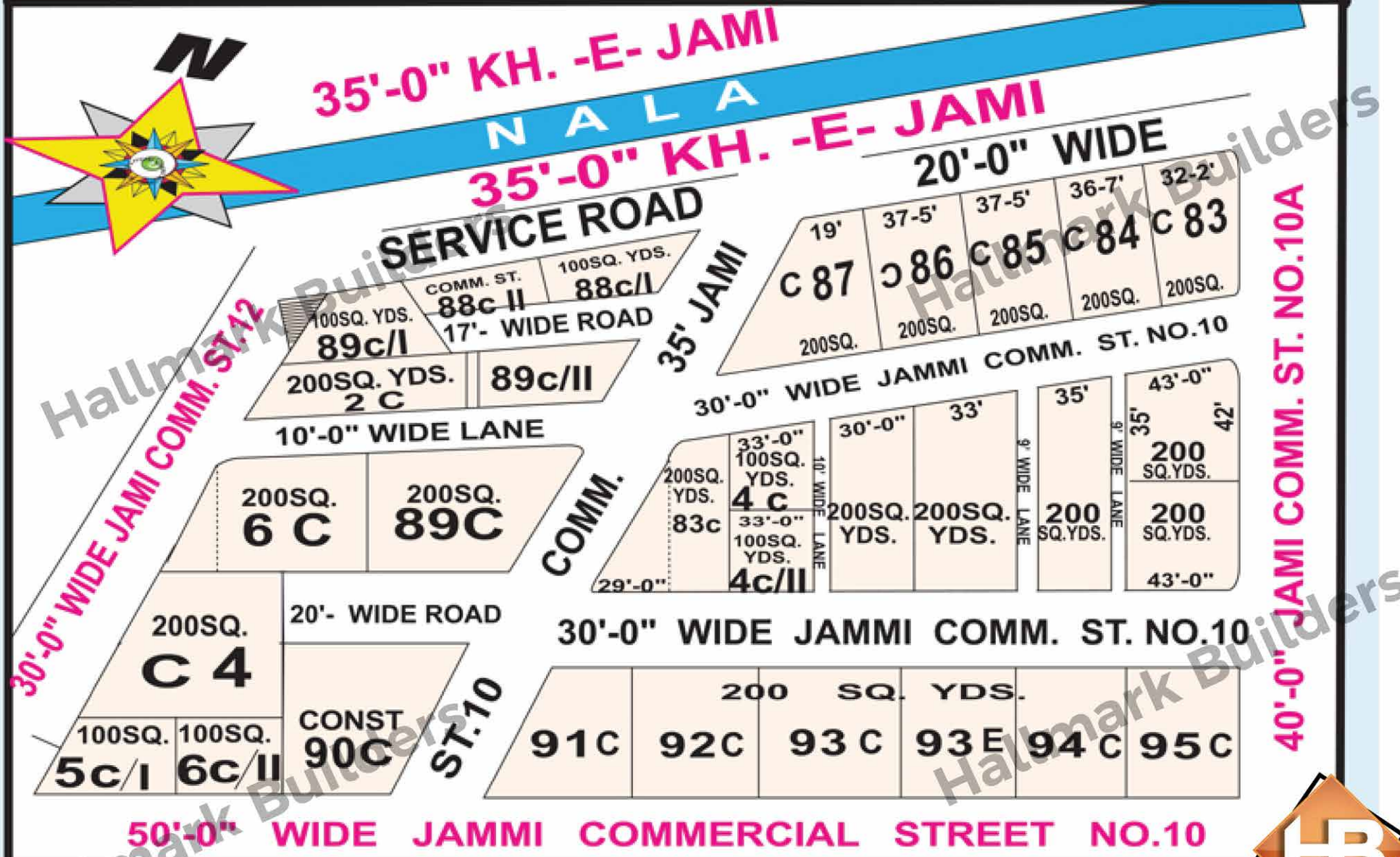

40'-0" JAMI COMM. ST. NO.10A





# ZULFIQAR COMM. & ALMURTAZA COMM.

## PHASE VII D.H.A KARACHI

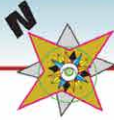

### 80'-0" WIDE ZULFIQAR AVENUE

### 80'-0" WIDE ZULFIQAR AVENUE



### 60' - 0" WIDE KHAYABAN - E - SHAHEEN

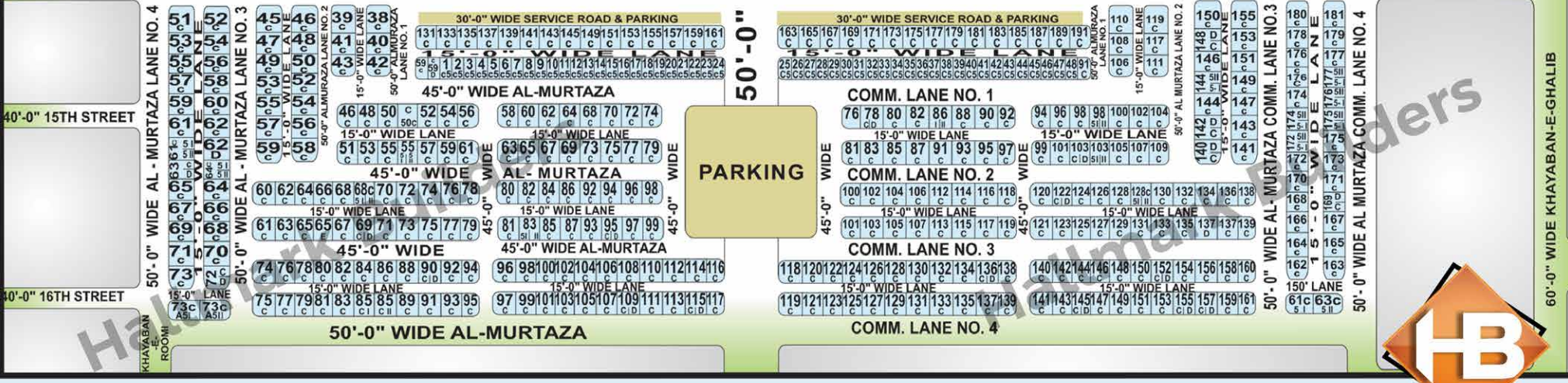



# SAHIL COMMERCIAL D.H.A PHASE VIII (E-8)

